

Title:

## **FREQUENCY RESPONSE FUNCTION OF A GUITAR - A SIGNIFICANT PEAK**

Author:

**SAMO ŠALI**

- Total number of pages: 20
- Number of Tables: 1
- Number of Figures: 10
  
- Postal address (for proofs):  
Dr. Samo Šali, Litostrojska 19,  
1000 Ljubljana,  
Slovenia

Summary:

A frequency response function (FRF) of a classical guitar was measured. The input signal was a mechanical impulse at the bridge and the response signal was a sound pressure at 1 m from the soundhole. This resulted in a single FRF similar to the average of several FRFs where excitation was located at the different places on the soundboard. The excitation at the bridge FRF is a reliable measure of the acoustic properties of a guitar. The measured FRF showed a high degree of linearity and had a high value of the coherence function between 70 - 250 Hz. The first resonant peak of the FRF is a result of interaction of the *soundboard-air-back* triplet [1 - 3]. The first resonant peak showed a significant correlation with the loudness of six tones. This significant peak of the FRF can be used in measuring and modeling the guitar's response with the aim to develop a procedure for optimizing the position of braces on the soundboard of the guitar.

## 1. INTRODUCTION

The aim of our experiments [4, 5] was to build a simple model for the guitar's FRF which should lead into developing a method for optimizing the position of braces on the soundboard of the guitar [6]. Developing a method for measuring the FRF, which correlates with the loudness of guitar tones, was one of the basic tasks. J. Curtin [7] states that the intensity of sound radiation of the violin should be as high as possible in all registers. It is reasonable to expect that the same would be true for the guitar. To the best of our knowledge complaints about instruments being too loud are not known. One can suggest that the FRF of the guitar whose amplitude correlates with the loudness of the played tones is an appropriate criterion for the instrument quality [2, 8]. Damping of key resonances is important, damping characteristics of the body of the musical instrument should not be too high and not too low [2, 9]. High damping results in a high decay of the played tones and too low damping in an unacceptably slow response time [2, 6] of the instrument. Excessive damping of the played tones is a characteristic of bad instruments [9]. A FRF of the guitar that can quantify the damping is an appropriate measure of the instrument's quality. The first resonant peak in the FRF of the guitar corresponds to the interaction of the *soundboard-air-back* triplet and should be near 85 Hz or lower [1, 2]. However, G. Eban says that there are excellent instruments with this frequency around 99 Hz [1]. We assume that the frequency of the first resonant peak in the FRF of the guitar can help to define guitar quality [10, 11].

If the first resonant peak in the FRF of the guitar is a normal (independent) mode then its low frequency indicates a low ratio of modal stiffness to modal mass. To lower the frequency of this mode smaller brace heights and smaller soundboard thickness are desired. Because in these cases the stiffness decreases more rapidly than the mass resulting in a lower natural frequency of the braced soundboard. If the first resonant peak in the FRF of the guitar is a normal mode then a decrease in the frequency of this peak, which is most probably a result of a decrease in dimensions of braces and boards of the guitar, is preferred. The energy contained in a vibrating string is limited and the amplitudes of vibrations of relatively light guitar soundboards are relatively high in general, which is a desired feature [6].

We hypothesises that the, mechanical impulse at the bridge to sound pressure at 1 m from the soundhole, FRF is an appropriate (but probably not sufficient) criterion for the guitar quality. Furthermore we feel the following statements are true [4, 8 - 11]: (i) the amplitude of the first resonant peak is higher for a good in comparison to a bad guitar, (ii) the damping of the first resonant peak is relatively low for the good guitar in comparison to a bad guitar, and (iii) the frequency of the first resonant peak is rather lower in a good guitar in comparison to a bad guitar. In this paper a method for the measurement and analysis of the mechanical impulse at the bridge to sound pressure at 1 m from the soundhole FRF is presented.

## 2. METHODS AND RESULTS

Two questions had to be answered in the beginning of measurements of the FRF of the guitar: (i) how to excite a guitar, and (ii) where to excite it? The answer to the first question can be found in Figure 1 where a measurement arrangement for measuring the FRF of the guitar is presented [12]. The arrangement is adopted from the measurements of the FRF of wooden boards [13]. Briefly, a sliding mass is released which impacts the weight-with-accelerometer, this impulsively excited the guitar indirectly through the foam rubber F1, which results in one notable pulse and several secondary pulses with relatively small amplitude. Foam rubber F2 prevents additional impacts between the sliding weight and the weight-with-accelerometer after the first impact. During FRF measurement (1.024 seconds) the guitar is not in contact with the weight-with-accelerometer. The foam rubber F1 and elastic-lines on which the weight-with-accelerometer was suspended provide a rebound of the weight-with-accelerometer after the impact into the bridge. A 0.65-gram accelerometer was used instead of a force transducer, which means that the units of the input signal are  $\text{m/s}^2$ , but because of the constant mass of the weight-with-accelerometer these units are proportional to Newton units. A condenser microphone measured the response of the guitar, so the response signal was measured in Pa.

To answer the question where to excite the guitar the following experiment was performed. The soundboards of a bad guitar and of good guitar #1 were excited at 42 places as shown in Figure 2. The resulting average FRFs for these 42 excitation locations are presented (Figure 2). To prevent the guitar

strings from vibrating a foam rubber block was inserted between the strings and the guitar neck during these measurements. The quality of both guitars was assessed based on a thorough analysis which resulted in an objective criterion for guitar quality determination called the rule of consonance-dissonance (i.e., RC-D) [14]. In addition, their price was at a ratio 1:10 which was also in agreement with subjectively judged characteristics of tones: The richness and loudness of the timbre of the tones of the good guitar in comparison to the bad guitar were obvious. The good guitar enabled quality playing of quiet tones as well as loud tones, which was not the case for the bad guitar with bad dynamic capability. The buzz tone in the bad guitar was relatively frequent. Briefly, the RC-D, which was expressed in a mathematical form and interpreted in terms of the physical and musical theory, enables a comparison of aesthetic quality of any two guitar tones of the same pitch if they were recorded under certain and equal conditions. The RC-D is based on experimentation with three different tones; “F” (87.3 Hz, 6th string), “B” (123.5 Hz, 5th string), and “g” (196.0 Hz, 3rd string), recorded in three different periods after string excitation. Our aim was to define a significant difference between good and bad guitar tones as produced by good and bad classical guitars, respectively. The first 15 frequency lines (rms values) of a discrete amplitude spectrum of a good tone were compared to those of a bad tone. Each amplitude spectrum can be seen as a host of intervals and the interval consists of two frequency lines. To consider a typical response of a human ear A-weighted sound pressure levels of 19 consonant and 6 dissonant intervals in dB(A) units were analyzed. The experiment showed that in comparison to bad tones the timbre of good tones consists of stronger consonant (pleasant) and weaker dissonant (unpleasant) intervals.

Presumably the most appropriate place of excitation on a guitar is somewhere at the bridge because this is the place of string fixation (driving point) [15]. If a method of measuring the FRF with excitation at only one position on the bridge would result in the FRF similar to the average FRF (see Figure 2) then this method is adequate for determination of acoustic properties of the guitar. Figure 3 shows the FRFs for the bad guitar and good guitar #1 at a fixed place of excitation. A foam rubber was inserted between the strings and neck as in measurements of the average FRF. Changing the place of excitation at the bridge did not significantly influence the resulting FRF. The coherence function in the region between 70 - 400 Hz was for all measurements above 0.95. Comparing Figures 2 and 3 one can see that the similarity between the average FRF measured over the soundboard and the FRF measured at the bridge. The differences between both tested guitars in this frequency region are equally evident from both Figures 2 and 3. We concluded that the described FRF (excitation at the bridge between the 5th and 6th string) is a significant and reliable substitute for the average FRF of the guitar.

One of the most desired features of the FRF is its linearity in a frequency range of interest. The FRF should be independent of the intensity of excitation, thus of the distance between the slide and weight-with-accelerometer denoted as  $d$  (see Figure 1). Figure 4 shows the average FRFs (calculated from 50 single FRFs) for  $d=230$ ,  $d=300$  and  $d=460$  mm, separately. The position of excitation was between the bridge and the soundhole, but this insignificant effect of  $d$  was typical of many measurements when the excitation was applied on the board or on the bridge. One can see that the amplitude, damping and frequency of the resonant peaks in a limited frequency range are nearly independent of the intensity of excitation. Therefore we can conclude that the analyzed system *excitation-guitar-response* is approximately linear between 70 - 250 Hz. In the experiments that followed  $d$  was constantly 290 mm.

Figure 5 shows FRFs of the good and bad guitars presented in Figure 3 along with an additional FRF of another good guitar (excitation at the bridge). The three FRFs are typical of FRF measurements of over 40 good and bad guitars. From the amplitude diagram one can see that (i) the amplitude of the first resonant peak in the FRF for the good guitars is larger in comparison to the amplitude of this peak corresponding to the bad guitar, and (ii) the damping of the first resonant peak in the FRF for the good guitars is smaller in comparison to the damping of this peak corresponding to the bad guitar [7]. From the phase diagram it is evident that (i) the frequency of the first resonant peak corresponding to the good guitars can be lower or higher than the frequency of this peak corresponding to the bad guitar, and (ii) the first resonant peak corresponds to a normal mode because the response signal lags the input signal by 90 degrees.

From the above we can surmise that the first resonant peak in the FRF of the guitar is at least a partial criterion for the guitar quality or more precisely for its tonal quality. According to [1 - 4, 16] the first resonant peak of all three FRFs from Figure 5 corresponds to the mode that is an interaction between the soundboard, back plate and the air inside the resonance box. A favorable acoustic response of both

plates and their interactions result in a favorable tonal quality of an instrument. Six tones of the bad and both good guitars were recorded at 1 m from the guitar: E (82.407 Hz - 6th string), A (110.0 Hz, 5th string), D (146.83 Hz, 4th string), g (196.0 Hz, 3rd string), b (246.94 Hz, 2nd string), and e1 (329.63 Hz, 1st string). A special plucking device was developed that ensured that the intensity, mode, and position of the excitation of the strings were repeatable. The tone recording was performed in the chamber shown in Figure 1 where the surrounding noise was at least 20 dB (0 dB  $\equiv$  20  $\mu$ Pa) below the sound pressure level (*i.e.*, SPL) of any frequency of interest. The plucking device is shown in Figure 6 and its operation is shown schematically in Figure 7: During the tone recording the electric motor was stopped providing a tone recording without disturbances. The tones were recorded for 0.256 seconds. A variable in these measurements was a time interval between the string excitation and start of recording. The time interval between the string excitation and start of tone recording was 0.2 s and 0.6 seconds. A dBA weighted SPL of first 15 frequency components was calculated from the discrete amplitude spectrum. This spectrum was obtained with Fast Fourier Transformation of the recorded signal (frequency resolution was 3.90625 Hz). The differences between the bad guitar and both good guitars are shown in Figure 8. These differences are typical of more than 20 comparisons between of good and bad guitars which are also in agreement with the rule of consonance-dissonance [14].

### 3. DISCUSSION

Figure 9 schematically shows a generalization of the described experiments. It is evident that regardless of the pitch of tone the SPL is always higher for the tones of a good guitar at least in the beginning of tone duration. For the tones recorded at approximately 0.5 seconds or sooner after the string excitation we can with high certainty conclude that a relatively high SPL is related to the relatively high amplitude of the first resonant peak in the FRF. In practice, a quality of guitar tones is usually similar for a certain guitar, thus we can assume that the amplitude of this peak is a reliable criterion for the SPL (loudness) of all tones recorded relatively soon after the string excitation. Since a relatively fast response of a guitar, which is significant for good instruments, means also a relatively strong decay rate of the played tones [6], relatively low SPL of tones D and b (0.6 s after string excitation) corresponding to the good guitar #1 is not surprising (see Figure 8). From Figure 5 it is evident that both damping and frequency of the first resonant peak in the FRF of a good guitar #2 are lower than of the other good guitar and bad guitar. Regardless of the time between the string excitation and start of recording, the SPL of the analyzed tones was significantly higher or slightly lower for a good guitar #2 in comparison to the other two guitars. This is in agreement with the assumption about superiority of relatively low damping and low frequency of the first resonant peak in the FRF of the guitar (see section 1). However, the relation between the damping and frequency of this resonant peak, on the one hand, and the SPL and decay rate of the guitar tones, on the other hand, is not so evident as the relation between the amplitude of this resonant peak and SPL of the tones. For example, the damping of the analyzed resonant peak in the FRF is the lowest for the good guitar #2 but the tones D and b are more damped than those of the other two guitars. It is reasonable to conclude that (i) relatively low values of both damping and frequency of the first resonant peak in the FRF of the guitar are desirable, and (ii) that the relation between these two characteristics and the tonal quality of the instrument is physically hard to explain.

### 4. BRACING STUDY

A test guitar was used to study the role of the large brace as indicated in Figure 10 (a). Two different positions of the large brace were studied. The role of this brace on the characteristics of the six tones 0.2 and 0.6 s after the string excitation and on the relative and dimensionless characteristics of the first resonant peak in the FRF of the guitar are shown in Figures 10 (b) and 11, and Table 1. One can see that a significantly higher amplitude, significantly lower damping, and slightly higher frequency of the first resonant peak in the FRF of the test guitar with the large brace at position r1 in comparison to position r2. The test guitar with a significantly higher (only in one case lower) SPL of all six tones has the large brace on position r1. The additional tests with a variable position of the large brace showed that a relatively low frequency of the first resonant peak in the FRF of the guitar can also result in a relatively high SPL of the

six tones. These results agree with the assumption that the position of the first resonant peak in the FRF of the guitar is not the only significant indicator of the quality of a guitar (see section 1) [2].

## 5. CONCLUSION

A method for measuring the FRF of the guitar where excitation was performed by a mechanical impulse at the bridge and response signal was a sound pressure at 1 m from the guitar has been developed. The place of excitation at the bridge indicates a typical response. Namely, the mean value of several FRFs where the excitation was performed at different locations on the soundboard was similar to the FRF where the excitation was performed at the bridge. The first resonant peak in this FRF is near 100 Hz and according to [1 - 4, 16] it is a result of interaction of the *soundboard-air-back* triplet. Based on analysis of the phase diagram of the FRF the first resonant peak corresponds to a normal mode, thus independent of any other modes. Under the given circumstances, both linearity of the FRF and the value of coherence function are relatively high in the region between 70 - 250 Hz.

Based on the research which resulted in the rule of consonance-dissonance [14] and on the measurements of over 40 good and bad guitars the differences in their FRFs and SPL of six tones can be presented by one bad and two good guitars (see Figures 5, 8 and 9). It seems that the amplitude of the first resonant peak in the FRF of the guitar is correlated with the SPL of the guitar tones at least in the beginning of tone duration [8, 10, 11]. In addition, it is very likely that relatively low damping and frequency of this peak result in a relatively good tonal quality of an instrument [1, 9]. So far, an exact physical explanation of this effect has not been tackled due to the complex modal behavior of the guitar body. A function which correlates the amplitude, damping and frequency of the first resonant peak in the FRF of the guitar [5] would be useful to accurately define (i) a criterion for guitar quality definition, and (ii) the aim of guitar quality optimization.

## Acknowledgments

We especially thank to Dr. Evan B. Davis who inspired us and helped us to improve the quality of this paper.

## REFERENCES

1. G. EBAN 1998 Proceedings - *International symposium on musical acoustics*, Acoustical Society of America, Catgut Acoustical Society. Leavenworth, Washington, 97 - 102. The Relation of Musical Acoustics Research to Guitar design and Building.
2. FLETCHER, N. H. and ROSSING, T. D. 1998 *The Physics of Musical instruments*, Springer-Verlag, New York, 239 - 271.
3. O. CHRISTENSEN and B. B. VISTISEN 1980 Simple Model for Low-Frequency Guitar Function, *Journal of Acoustical Society of America*, No. 68(3), 758 - 766.
4. S. ŠALI and J. KOPAČ 2000 Measuring a Frequency Response of a Guitar, *Proceedings of IMAC*, Society for Experimental Mechanics, San Antonio, TX, 1375-1379.
5. S. ŠALI and J. KOPAČ 2001 Modeling and Optimizing of Frequency Response Function of a Guitar (accepted by *Experimental Mechanics* - Society for Experimental Mechanics).
6. B. E. RICHARDSON 1983 The influence of strutting on the top-plate modes of a guitar, *Catgut Acoustical Society Newsletter*, No. 40, 13 - 17.
7. J. CURTIN 1998 Proceedings - *International symposium on musical acoustics*, Acoustical Society of America, Catgut Acoustical Society. Leavenworth, Washington, 11-16. Innovation in Violinmaking.
8. Ricardo. R. BOULLOSA, F. ORDUNA-BUSTAMANTE, A. Perez LOPEZ, 1999 Tuning Characteristics, Radiation Efficiency and Subjective Quality of a Set of Classical Guitars, *Applied Acoustics*, No. 56, 183 - 197.
9. G. BISSINGER 1999 Modal Analysis of Assembled String Instruments: The VIODEAS Project – A Progress Report, *Catgut Acoustical Society Journal*, Vol. 3, No. 8, 19 – 23.

10. S. M. MARTY, B. F. OREB and P. HARIHARAN 1987 Assessment of Innovations in the Construction of the Classical Guitar: Part I. Analysis of Top-Plate Resonances Using FFT Techniques and Holographic Interferometry, *Catgut Acoustical Society Journal*, No. 47, 26 – 29.
11. S. M. MARTY, B. F. OREB and P. HARIHARAN 1987 Assessment of Innovations in the Construction of the Classical Guitar: Part II. New Developments in Guitar Construction, *Catgut Acoustical Society Journal*, No. 47, 30 – 33.
12. Ricardo R. BOULLOSA 1981 The Use of Transient Excitation for Guitar Frequency Response Testing, *Catgut Acoustical Society Newsletter*, No. 36, 17 - 20.
13. J. KOPAČ and S. ŠALI 1999 *Journal of Sound and Vibration*. The frequency response of differently machined wooden boards 227(2), 259 - 269.
14. S. ŠALI and J. KOPAČ 2000 Measuring the Quality of Guitar Tone, *Experimental Mechanics*, Vol. 40, No. 3, 242 - 247.
15. G. CALDERSMITH 1995 Designing a Guitar Family, *Applied Acoustics*, No. 46, 3 – 17.
16. E. B. DAVIS 1998 Proceedings - *International symposium on musical acoustics*, Acoustical Society of America, Catgut Acoustical Society. Leavenworth, Washington, 91 - 95. A “New” Window on Tone, Re-scaling Frequency response Functions.

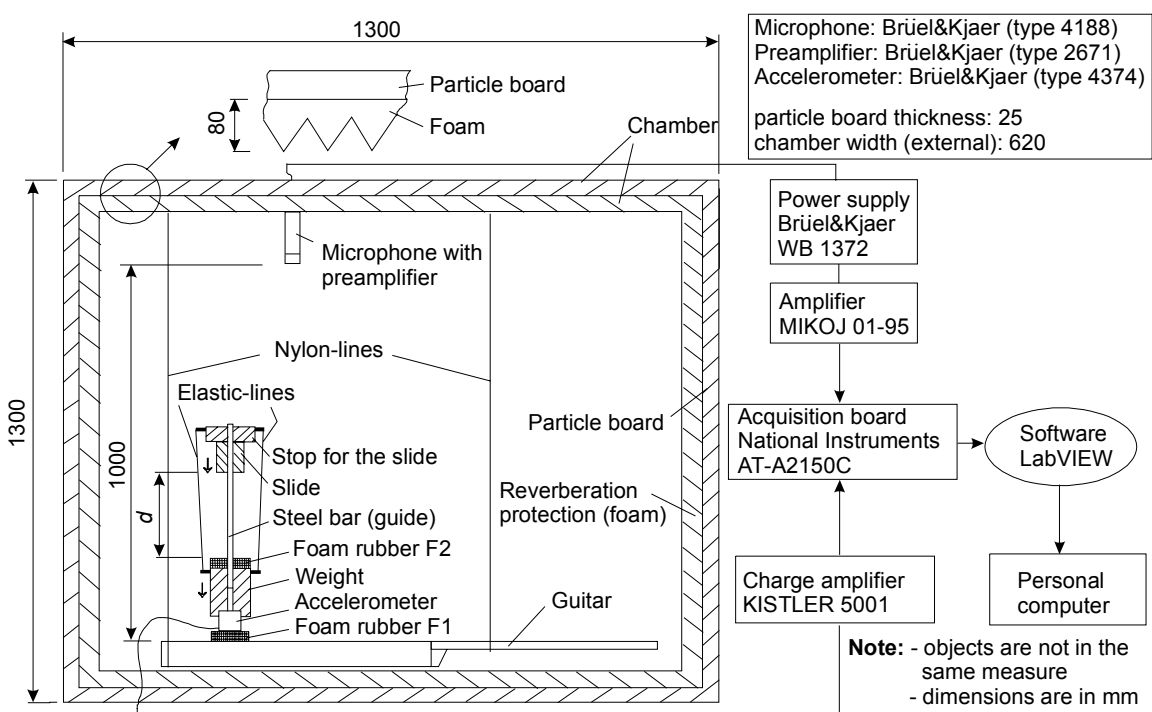
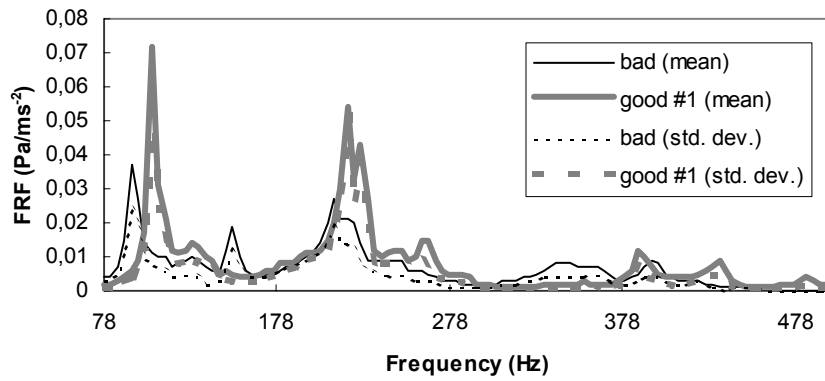

Figure 1. Measurement arrangement.



Positions of excitation:

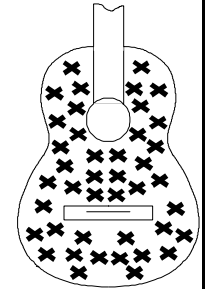

Figure 2. The average FRF for the bad and good guitar #1.

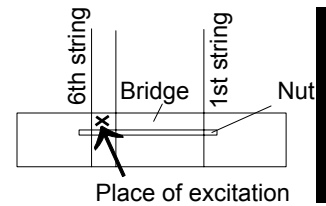
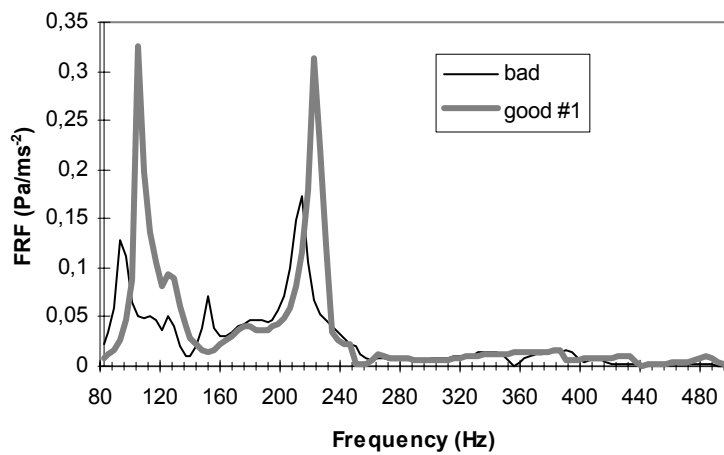

Figure 3. The FRF for the bad and good guitar #1

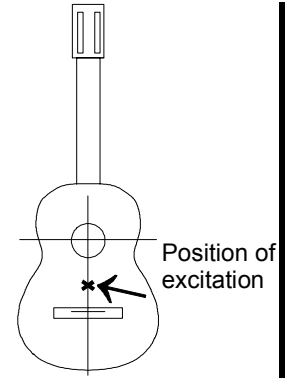
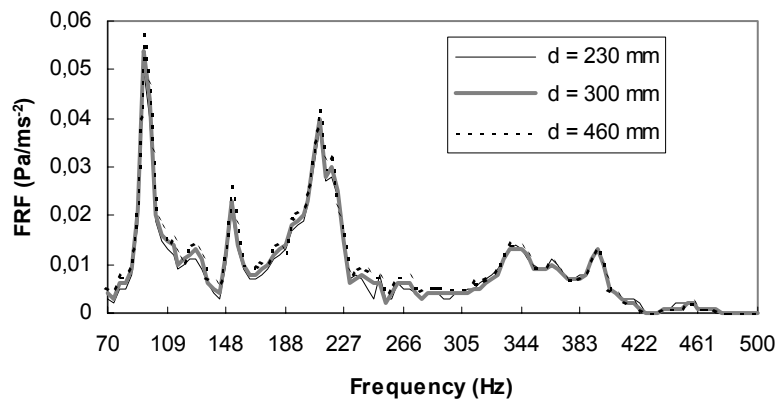
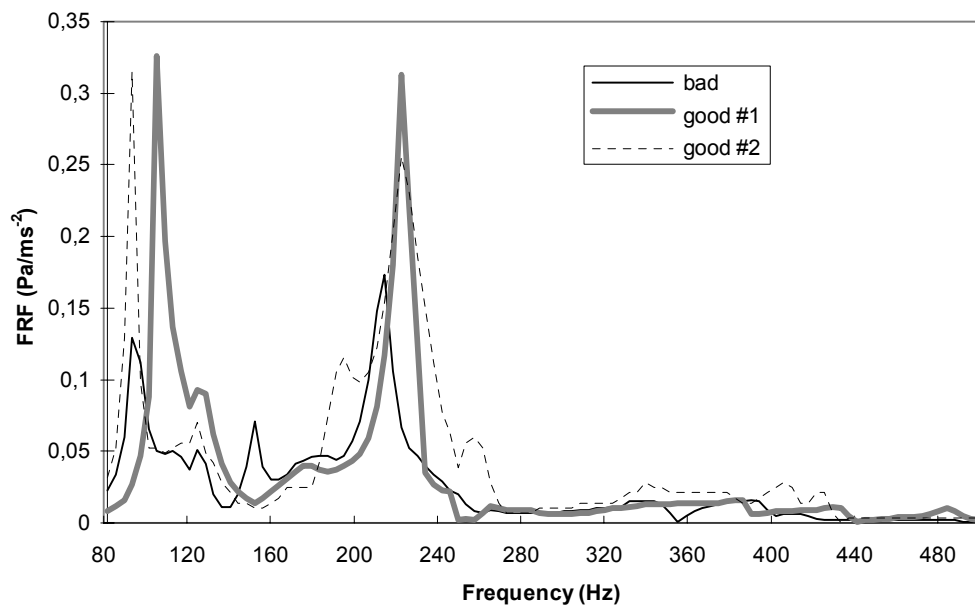

Figure 4. The FRF in dependence on  $d$  (bad guitar).





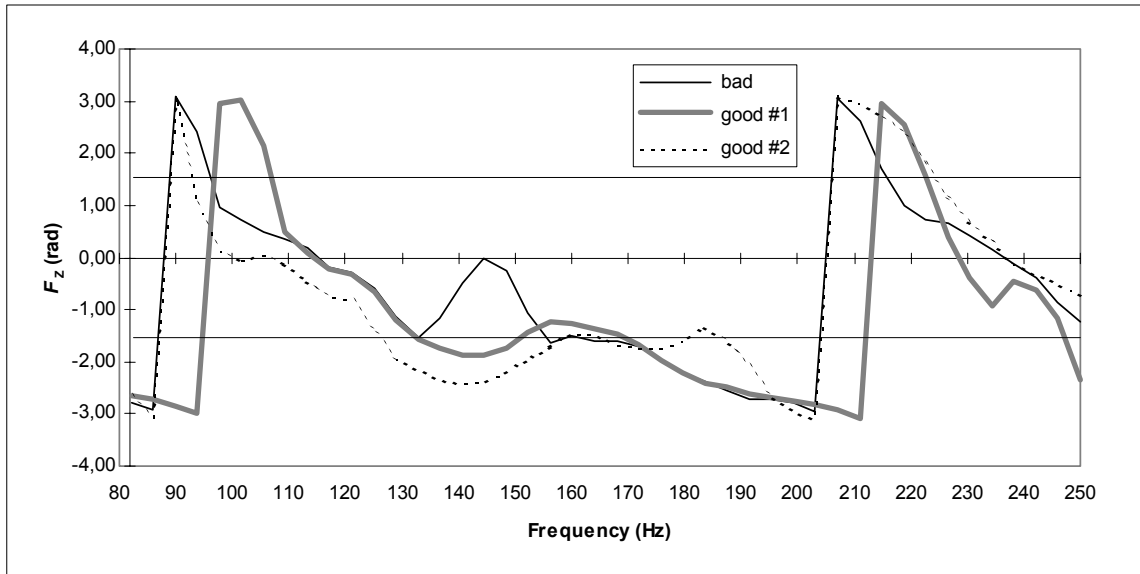

Figure 5. Amplitude and phase diagrams of the FRF for the bad and good guitars ( $P_L$  is lag of response signal).

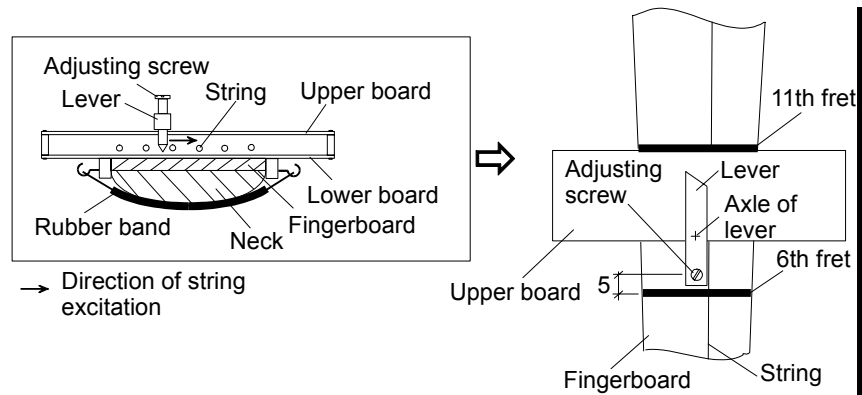

Figure 6. The string excitation device and its mounting.

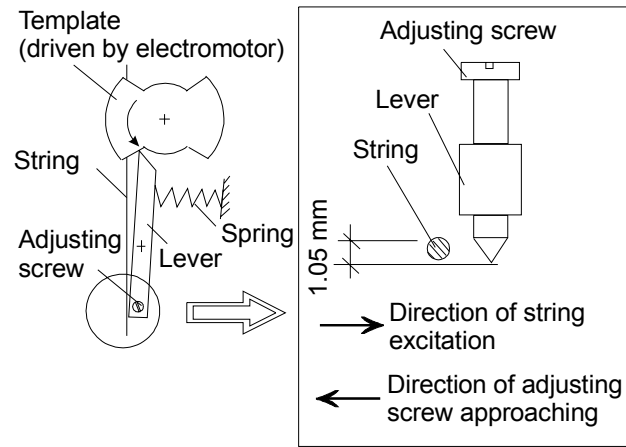
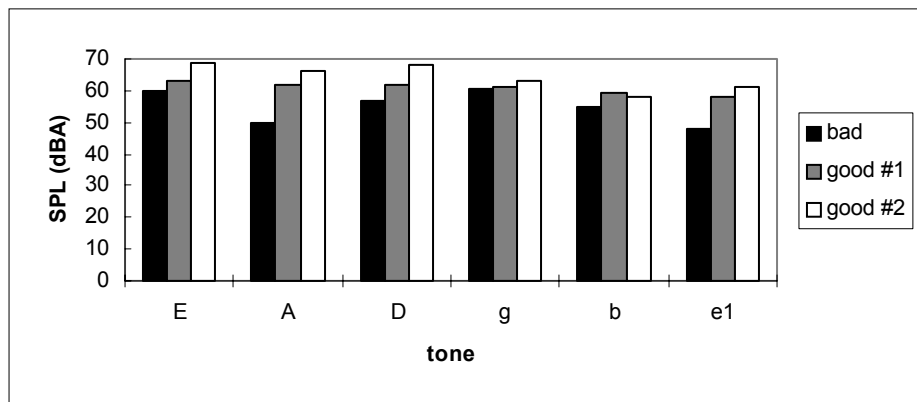
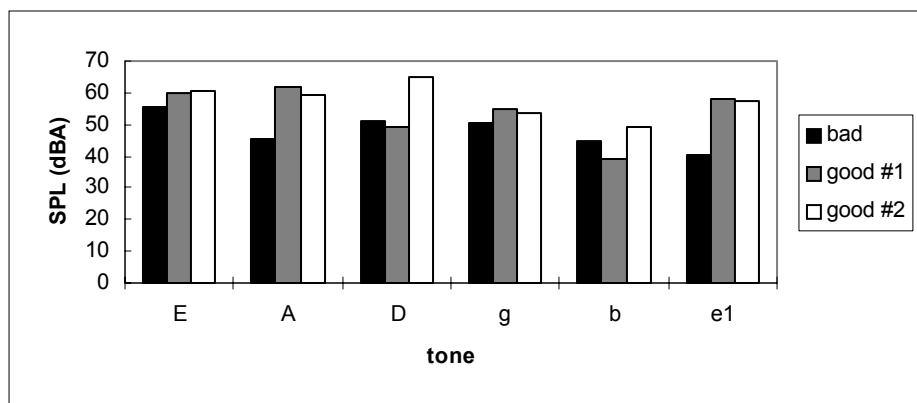

Figure 7. The operation of string excitation device (schematically).



(a)



(b)

Figure 8. Characteristics of the tones: a) 0.2 s after string excitation; b) 0.6 s after string excitation.

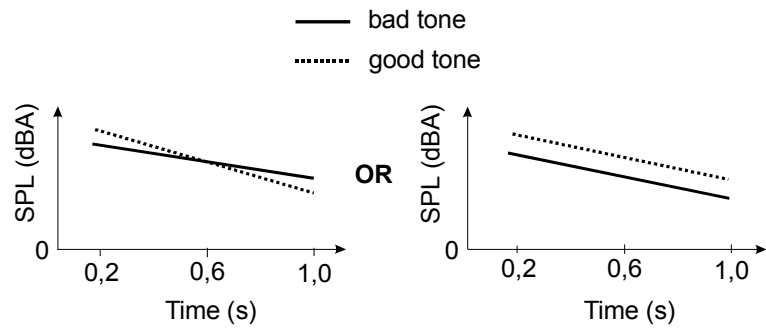
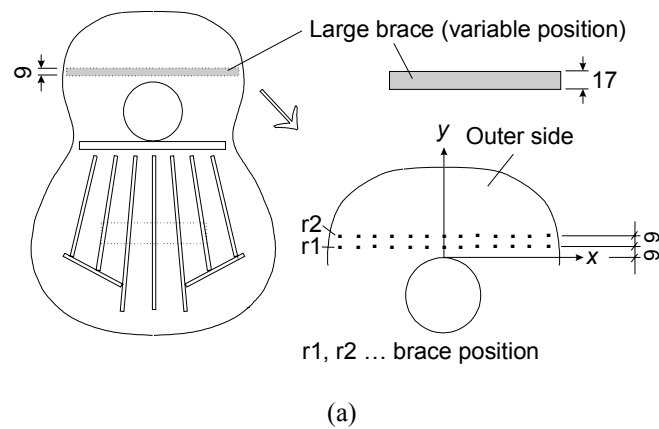

Figure 9. The difference between bad and good guitar tone (schematically).



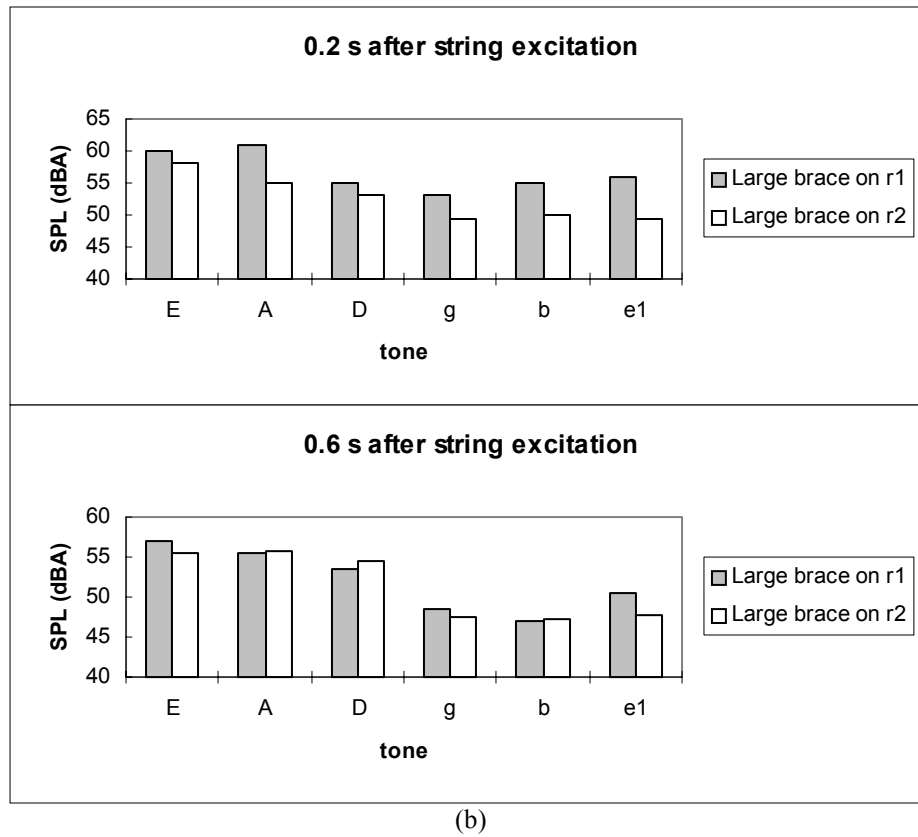

Figure 10. The effect of the large brace position on the test guitar: (a) Positions r1 and r2; (b) Characteristics of the six tones in 0.2 and 0.6 s after the string excitation.

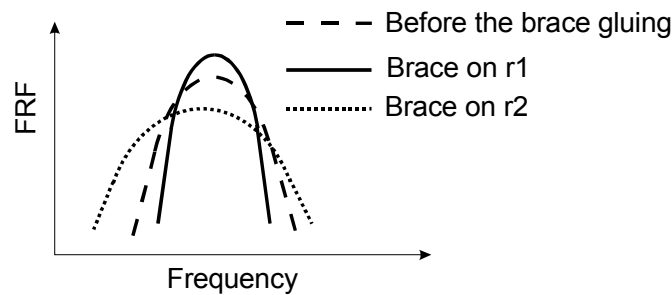

Figure 10. The effect of the two different brace positions on the first resonant peak in the FRF of the test guitar (schematically).

TABLE 1

Relative and dimensionless characteristics of the first resonant peak in the FRF of the test guitar.

	Amplitude	Damping	Frequency
Before the large brace gluing	1.00	1.00	1.00
After the large brace gluing on position <b>r1</b>	1.03	0.97	1.00
After the large brace gluing on position <b>r2</b>	0.72	1.68	0.99